

## Low Jitter Crystal Oscillator for Automotive: SG-8201CJA

### Features

- Crystal oscillator
- Output frequency: 1.2 MHz to 170 MHz
- Output: CMOS
- Supply voltage: 1.62 V to 3.63 V
- Frequency tolerance, Operating temperature:
  - $\pm 15 \times 10^{-6}$  / -40 °C to +105 °C
  - $\pm 25 \times 10^{-6}$ ,  $\pm 50 \times 10^{-6}$  / -40 °C to +125 °C
- Phase jitter: 1.1 ps Typ.  
(Offset freq.: 12 kHz to 20 MHz,  $f_0 = 125$  MHz)
- AEC-Q100 compliant

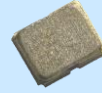

(2.0 × 1.6 × 0.6 mm)

### Description

Epson's SG-8201CJA is an AEC-Q100 compliant Crystal Oscillator designed for demanding Automotive/ADAS applications such as LiDAR and camera ECUs.

Utilizing an Epson's in-house low noise fractional-N PLL, it outputs frequencies up to 170 MHz with < 1/25th phase jitter and ~ 2x better stability compared to previous products SG-8101CGA.

Additionally, the small package size of 2.0 × 1.6 mm enables board space savings.

This SPXO can be used in small lots and quick turn-around time for any frequency in the range of 1.2 MHz to 170 MHz, contributing to automotive applications from development to mass production.

### Outline Drawing and Terminal Assignment

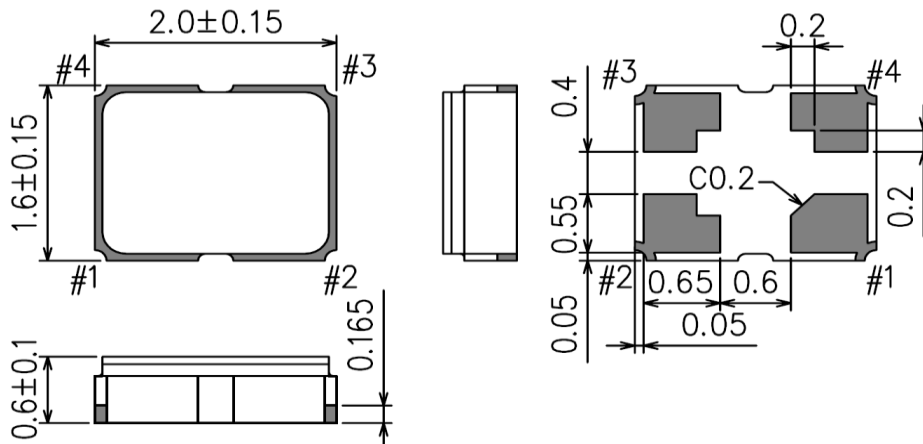

### Terminal Assignment

Pin #	Name	Function
#1	OE	Output Enable High <sup>*1</sup> or Open: Specified frequency output from OUT pin Low: OUT pin is low (pull down with 500 kΩ), only output driver is disabled
	$\bar{O}E$	Output Enable Low <sup>*2</sup> or Open: Specified frequency output from OUT pin High: OUT pin is low (pull down with 500 kΩ), only output driver is disabled
	ST	Standby High <sup>*1 *3</sup> : Specified frequency output from OUT pin Low: OUT pin is low (pull down with 500 kΩ) Device goes to standby mode. Supply current reduces to the least as I_std
	ST	Standby Low <sup>*2 *3</sup> : Specified frequency output from OUT pin High: OUT pin is low (pull down with 500 kΩ) Device goes to standby mode. Supply current reduces to the least as I_std
#2	GND	Ground
#3	OUT	Clock output
#4	V <sub>CC</sub>	Power supply

\*1 If fixing it at High, please connect to V<sub>CC</sub> directly.

\*2 If fixing it at Low, please connect to GND directly.

\*3 If necessary to use Open, please select Output Enable function.

## [ 1 ] Product Name / Product Number

(1-1) Product Name (Standard Form)

X1G005991xxxx16

(Please contact Epson for details)

## (1-2) Product Number / Ordering Code

SG-8201CJA 25.000000MHz T D J P A

① ② ③ ④⑤⑥⑦⑧

① Model ② Size ③ Frequency ④ Supply voltage (T: 1.8 V to 3.3 V Typ.)

⑤ Frequency tolerance ⑥ Operating temperature ⑦ Function ⑧ Rise/Fall time

② Size
CJ 2.0 mm x 1.6 mm

⑦ Function
P Output enable (#1pin = OE)
Q Output enable (#1pin = $\overline{OE}$ )
S Standby (#1pin = $\overline{ST}$ )
T Standby (#1pin = ST)

⑧ Rise/Fall time
A Default
B Faster
C Fast
D Slow
E Slower

⑤ Frequency tolerance / ⑥ Operating temperature
BH $\pm 15 \times 10^{-6}$ / -40 °C to +105 °C
DJ $\pm 25 \times 10^{-6}$ / -40 °C to +125 °C
JJ $\pm 50 \times 10^{-6}$ / -40 °C to +125 °C

## [ 2 ] Absolute Maximum Ratings

Parameter	Symbol	Specification			Unit	Conditions
		Min.	Typ.	Max.		
Maximum supply voltage	GND- $V_{CC}$	-0.3	-	4	V	GND = 0 V
Input voltage	$V_{IN}$	GND - 0.3	-	$V_{CC} + 0.3$	V	#1 pin
Storage temperature range	T_stg	-55	-	+150	°C	

## [ 3 ] Operating Range

Parameter	Symbol	Specification			Unit	Conditions
		Min.	Typ.	Max.		
Supply voltage	$V_{CC}$	1.62	-	3.63	V	
Supply voltage	GND	0.0	0.0	0.0	V	
Input voltage	$V_{IN}$	GND	-	$V_{CC}$	V	#1 pin
Operating temperature range	T_use	-40	+25	+105	°C	
		-40	+25	+125	°C	
CMOS load condition	L_CMOS	-	-	15	pF	

\* Power supply startup time (0 % $V_{CC}$  → 90 % $V_{CC}$ ) should be between 5  $\mu$ s and 500 ms\* A 0.01  $\mu$ F to 0.1  $\mu$ F or over bypass capacitor should be connected between  $V_{CC}$  and GND pins located close to the device

## [ 4 ] Frequency Characteristics

(Unless stated otherwise [ 3 ] Operating Range)

Parameter	Symbol	Specification			Unit	Conditions
		Min.	Typ.	Max.		
Output frequency	f <sub>o</sub>	1.2		170	MHz	
Frequency tolerance *1	f_tol	-15	-	+15	$\times 10^{-6}$	T_use = -40 °C to +105 °C
		-25	-	+25	$\times 10^{-6}$	T_use = -40 °C to +125 °C
		-50	-	+50	$\times 10^{-6}$	T_use = -40 °C to +125 °C
Frequency aging *2	f_age	Included in frequency tolerance			$\times 10^{-6}$	+25 °C, First year

\*1 Frequency tolerance includes initial frequency tolerance, frequency / temperature characteristics, frequency / voltage coefficient, frequency / load coefficient and frequency aging (+25 °C, first year)

\*2 Frequency aging is estimated from environmental reliability tests; expected amount of the frequency variation. This is not intended to be a guarantee of the product life cycle.

## [ 5 ] Electrical Characteristics

(Unless stated otherwise [ 3 ] Operating Range)

Parameter	Symbol	Specification			Unit	Conditions			
		Min.	Typ.	Max.					
Start-up time	t_str	-	-	3	ms	t = 0 at V <sub>CC</sub> > 1.62 V			
Current consumption (No load) V <sub>CC</sub> = 1.62 V to 1.98 V	I <sub>CC</sub>	-	5.2	7.0	mA	1.2 MHz ≤ fo ≤ 25 MHz			
		-	5.4	7.3		25 MHz < fo ≤ 50 MHz			
		-	5.7	7.7		50 MHz < fo ≤ 75 MHz			
		-	6.2	8.2		75 MHz < fo ≤ 100 MHz			
		-	6.9	9.4		100 MHz < fo ≤ 125 MHz			
		-	7.8	10.4		125 MHz < fo ≤ 170 MHz			
Current consumption (No load) V <sub>CC</sub> = 2.25 V to 2.75 V	I <sub>CC</sub>	-	5.4	7.2	mA	1.2 MHz ≤ fo ≤ 25 MHz			
		-	5.7	7.6		25 MHz < fo ≤ 50 MHz			
		-	6.3	8.2		50 MHz < fo ≤ 75 MHz			
		-	6.9	9.1		75 MHz < fo ≤ 100 MHz			
		-	7.9	10.7		100 MHz < fo ≤ 125 MHz			
		-	9.2	12.4		125 MHz < fo ≤ 170 MHz			
Current consumption (No load) V <sub>CC</sub> = 2.97 V to 3.63 V	I <sub>CC</sub>	-	5.6	7.5	mA	1.2 MHz ≤ fo ≤ 25 MHz			
		-	6.1	8.1		25 MHz < fo ≤ 50 MHz			
		-	7.0	9.1		50 MHz < fo ≤ 75 MHz			
		-	7.9	10.4		75 MHz < fo ≤ 100 MHz			
		-	9.1	12.4		100 MHz < fo ≤ 125 MHz			
		-	11.2	15.0		125 MHz < fo ≤ 170 MHz			
Disable current	I_dis	-	5.0	7.2	mA	V <sub>CC</sub> = 1.62 V to 1.98 V			
		-	5.0	7.3		V <sub>CC</sub> = 2.25 V to 2.75 V			
		-	5.1	7.4		V <sub>CC</sub> = 2.97 V to 3.63 V			
Stand-by current	I_std	-	0.3	15.0	μA	V <sub>CC</sub> = 1.62 V to 1.98 V			
		-	0.3	15.0		V <sub>CC</sub> = 2.25 V to 2.75 V			
		-	0.5	15.0		V <sub>CC</sub> = 2.97 V to 3.63 V			
Output voltage (DC characteristics)	V <sub>OH</sub>	90 % V <sub>CC</sub>	-	-	V	Rise/Fall time			
						Default 'A' Option *1	Other Options	I <sub>OH</sub>	I <sub>OL</sub>
	V <sub>OL</sub>	-	-	10 % V <sub>CC</sub>	V	fo > 125 MHz	'B'	-2.0 mA	2.0 mA
						75 MHz < fo ≤ 125 MHz	'C'	-1.0 mA	1.0 mA
Symmetry	SYM	45	50	55	%	50 % V <sub>CC</sub> level, L_CMOS ≤ 15 pF			
						fo ≤ 50 MHz	'E'	-0.2 mA	0.2 mA
Rise/Fall time	tr/tf	-	-	2.0	ns	Default 'A' Option *1	Other Options	Conditions	
				2.5		fo > 125 MHz	'B'	20 % - 80 %	
				4.0		75 MHz < fo ≤ 125 MHz	'C'	V <sub>CC</sub> level,	
				6.0		50 MHz < fo ≤ 75 MHz	'D'	L_CMOS =	
Input voltage	V <sub>IH</sub>	70 % V <sub>CC</sub>	-	-	V	#1 pin			
	V <sub>IL</sub>	-	-	30 % V <sub>CC</sub>	V	#1 pin			
Input capacitance	C <sub>IN</sub>	-	3	5	pF	#1 pin			
Input pull up resistance (OE)	R <sub>UP1</sub>	-	40	-	kΩ				
Input pull up resistance (ST)	R <sub>UP1</sub>	-	40	-	kΩ	ST = 70 % V <sub>CC</sub>			
	R <sub>UP2</sub>	-	10	-	MΩ	ST = 30 % V <sub>CC</sub>			
Input pull up resistance (ST)	R <sub>UP1</sub>	-	40	-	kΩ				
Input pull down resistance (OE)	R <sub>DN1</sub>	-	40	-	kΩ				
Output pull down resistance	R <sub>DN</sub>	-	500	-	kΩ				
Output disable time (OE)	tstp_oe	-	-	1	μs	Measured from the time OE pin crosses 30 % V <sub>CC</sub> or measured from the time OE pin crosses 70 % V <sub>CC</sub>			
Output disable time (ST)	tstp_st	-	-	1	μs	Measured from the time ST pin crosses 30 % V <sub>CC</sub> or measured from the time ST pin crosses 70 % V <sub>CC</sub>			
Output enable time (OE)	tsta_oe	-	-	100 ns + 2 clock cycles	-	Measured from the time OE pin crosses 70 % V <sub>CC</sub> or measured from the time OE pin crosses 30 % V <sub>CC</sub>			
Output enable time (ST)	tsta_st	-	-	3	ms	Measured from the time ST pin crosses 70 % V <sub>CC</sub> or measured from the time ST pin crosses 30 % V <sub>CC</sub>			

\*1 Default 'A' Rise/Fall time is dependent on programmed frequency

(Unless stated otherwise [ 3 ] Operating Range)

Parameter	Symbol	Specification			Unit	Conditions
		Min.	Typ.	Max.		
Phase jitter	$t_{PJ}$	-	1.2	-	ps	fo = 25 MHz, Offset frequency: 12 kHz to 5 MHz
		-	1.2	-		fo = 50 MHz, Offset frequency: 12 kHz to 20 MHz
		-	1.2	-		fo = 75 MHz, Offset frequency: 12 kHz to 20 MHz
		-	1.2	-		fo = 100 MHz, Offset frequency: 12 kHz to 20 MHz
		-	1.1	-		fo = 125 MHz, Offset frequency: 12 kHz to 20 MHz
		-	1.4	-		fo = 150 MHz, Offset frequency: 12 kHz to 20 MHz
		-	1.5	-		fo = 170 MHz, Offset frequency: 12 kHz to 20 MHz

## [ 6 ] Thermal Resistance (For Reference Only)

Parameter	Symbol	Specification			Unit	Conditions
		Min.	Typ.	Max.		
Junction temperature	$T_j$	-	-	+150	°C	
Junction to case	$\theta_{jc}$	-	129	-	°C/W	
Junction to ambient	$\theta_{ja}$	-	257	-	°C/W	

## [ 7 ] Typical Performance Characteristics (For Reference Only)

The following data shows typical performance characteristics

## (7-1) Frequency / Temperature Characteristics

 $\pm 50 \times 10^{-6} / -40 \text{ }^\circ\text{C} \sim +125 \text{ }^\circ\text{C}$ 

n = 20 pcs

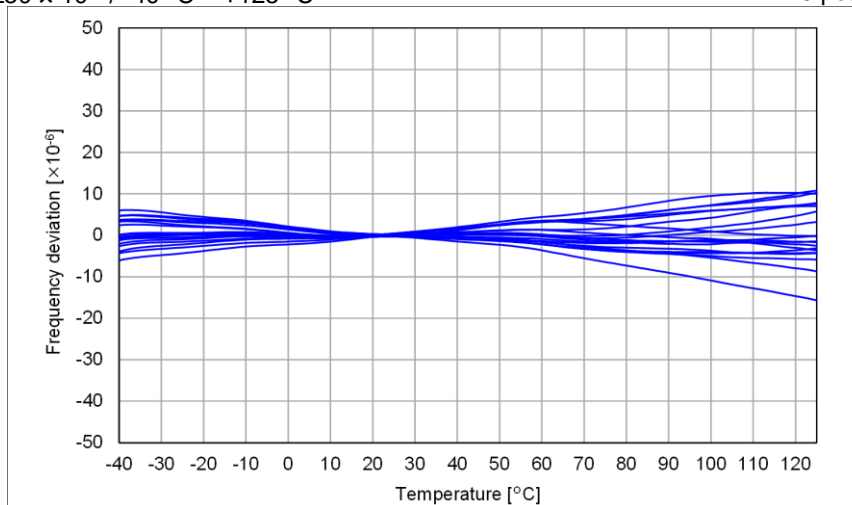
 $\pm 15 \times 10^{-6} / -40 \text{ }^\circ\text{C} \sim +105 \text{ }^\circ\text{C}, \pm 25 \times 10^{-6} / -40 \text{ }^\circ\text{C} \sim +125 \text{ }^\circ\text{C}$ 

n = 20 pcs

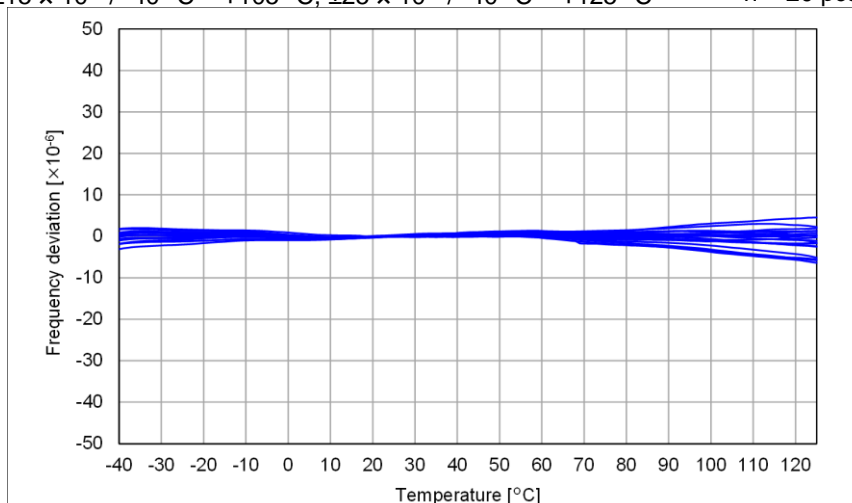

## (7-2) Current Consumption Temperature Characteristic (No load)

fo = 25 MHz

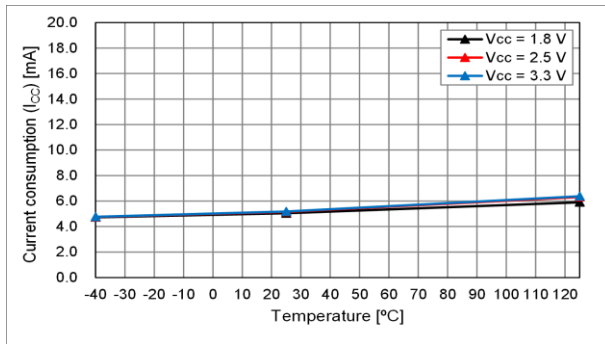

fo = 50 MHz

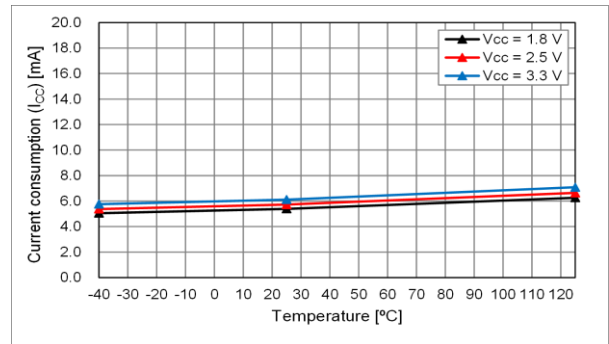

fo = 75 MHz

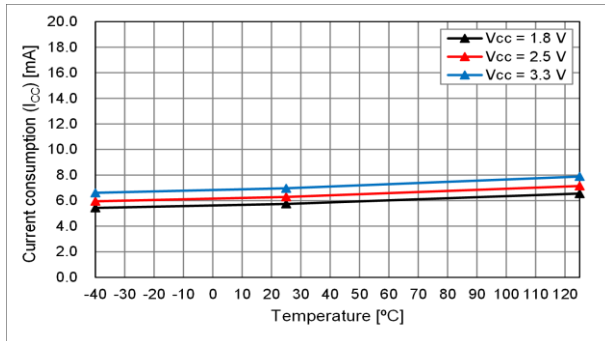

fo = 100 MHz

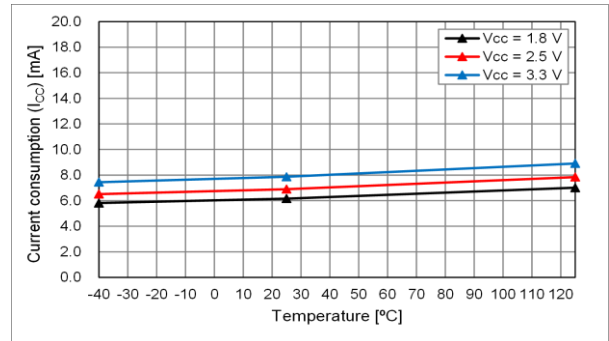

fo = 125 MHz

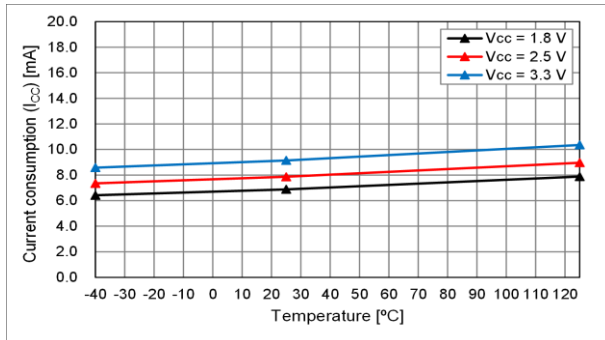

fo = 150 MHz

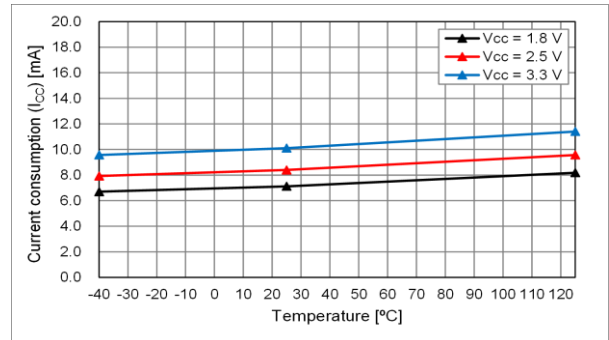

fo = 170 MHz

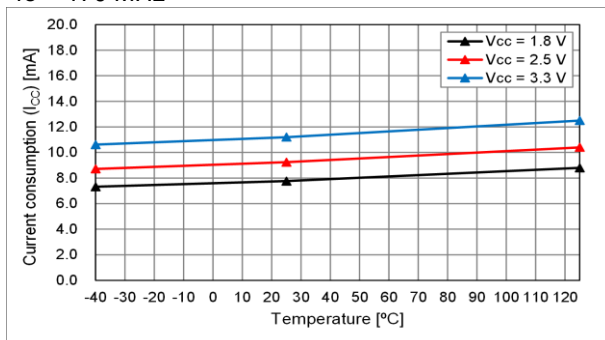

(7-2) Current Consumption [cont'd]  
 Frequency Dependency ( $T_{use} = +25\text{ }^{\circ}\text{C}$ )

No load

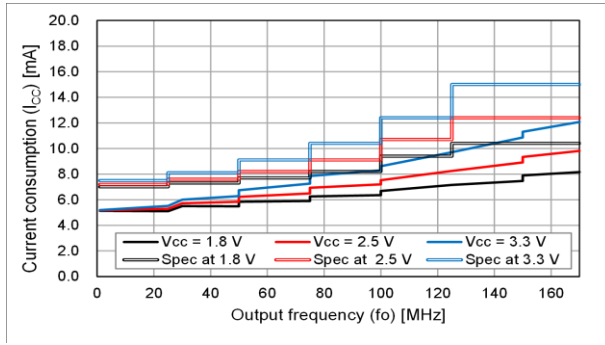

$L_{CMOS} = 15\text{ pF}$

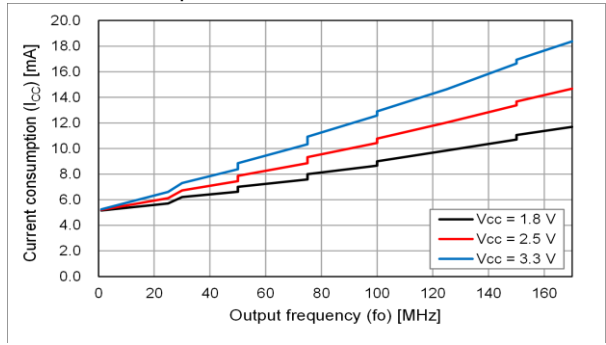

The actual current consumption is the total of the current under the condition of no load and the current to drive the output load ( $f_o \times L_{CMOS} \times V_{CC}$ ). To reduce the current consumption, it is effective to use lower frequency, lower supply voltage and lower output load.

(7-3) Rise/Fall Time  
 Temperature Characteristic ( $20\% - 80\%V_{CC}$ ,  $L_{CMOS} = 15\text{ pF}$ )  
 $f_o = 25\text{ MHz}$ , Rise/Fall time: A (Default) or E (Slower)

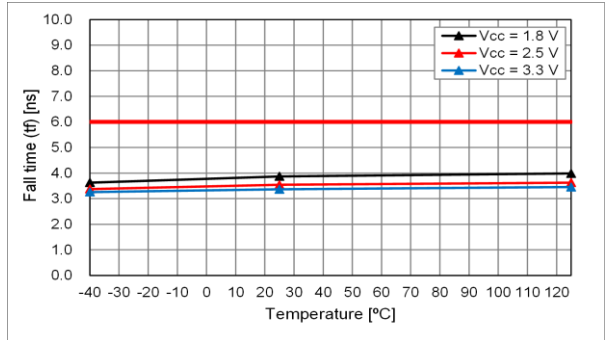
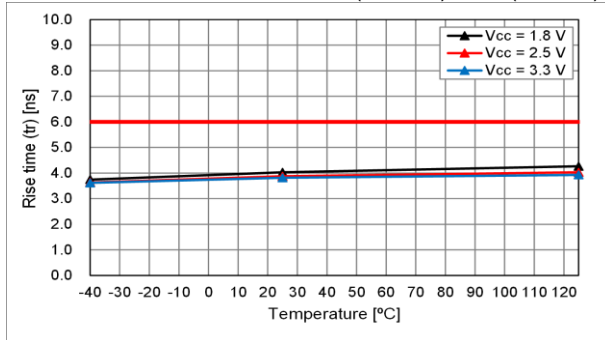

$f_o = 50\text{ MHz}$ , Rise/Fall time: A (Default) or E (Slower)

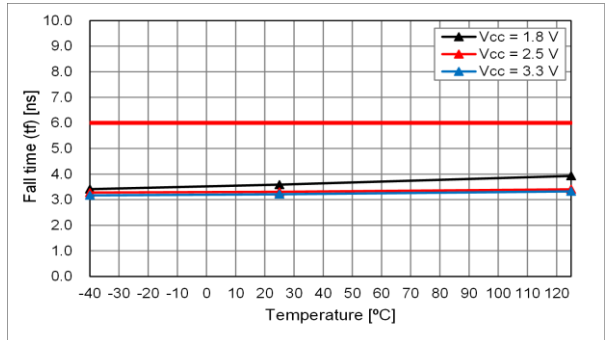
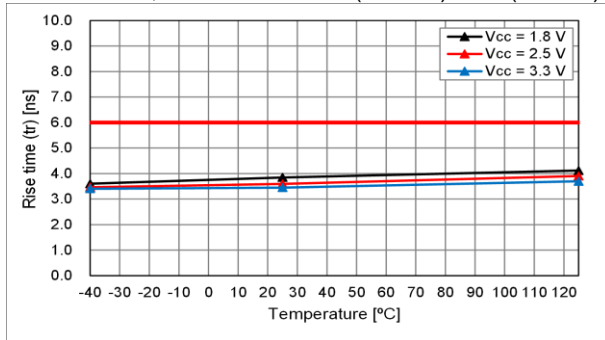

$f_o = 75\text{ MHz}$ , Rise/Fall time: A (Default) or D (Slow)

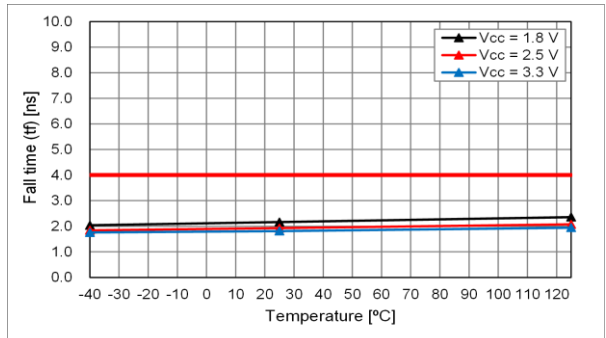
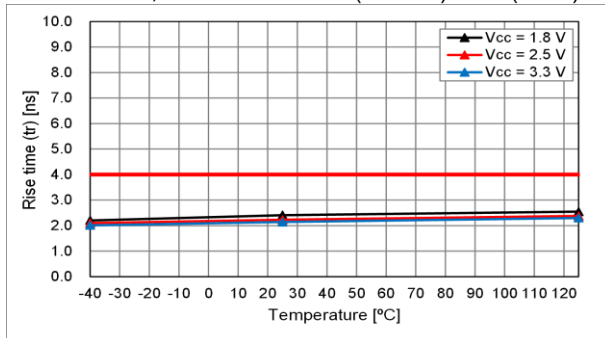

(7-3) Rise/Fall Time [cont'd]

Temperature Characteristic (20 % - 80 % $V_{CC}$ ,  $L_{CMOS} = 15$  pF)

$f_o = 100$  MHz, Rise/Fall time: A (Default) or C (Fast)

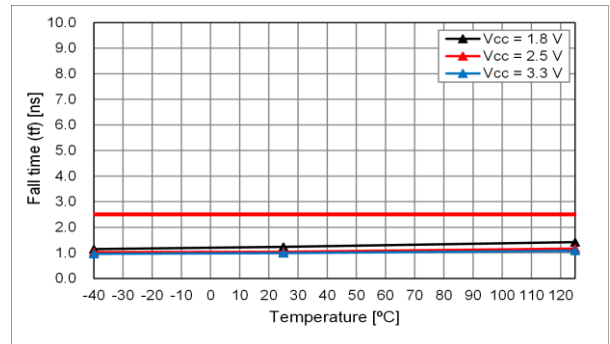
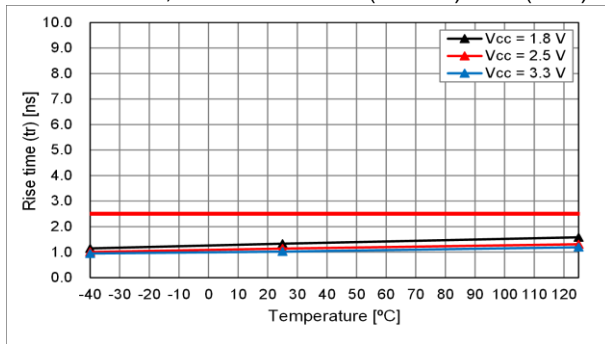

$f_o = 125$  MHz, Rise/Fall time: A (Default) or C (Fast)

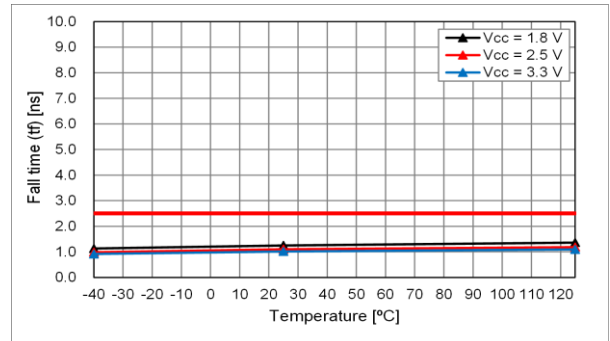
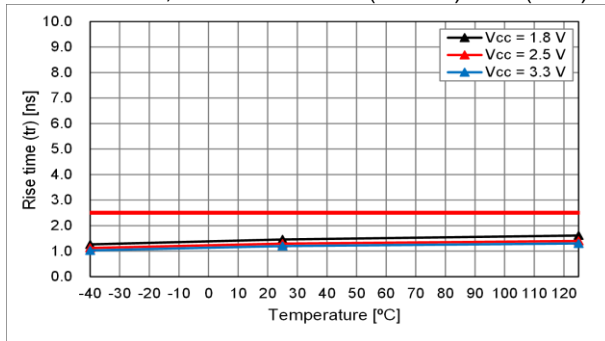

$f_o = 150$  MHz, Rise/Fall time: A (Default) or B (Faster)

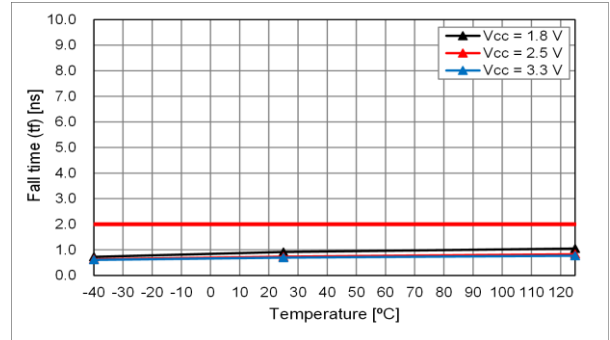
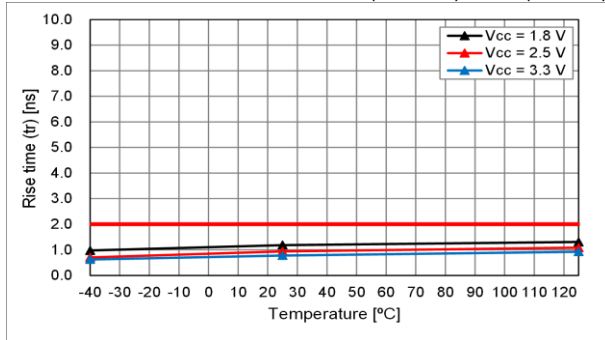

$f_o = 170$  MHz, Rise/Fall time: A (Default) or B (Faster)

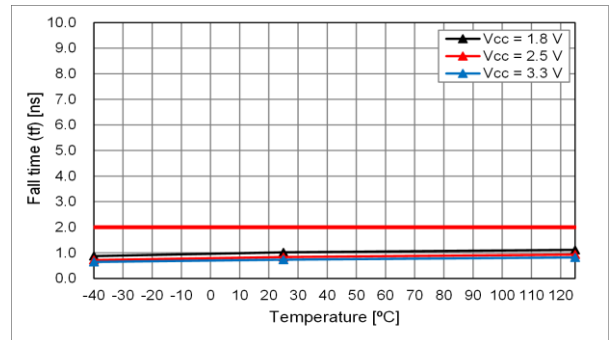
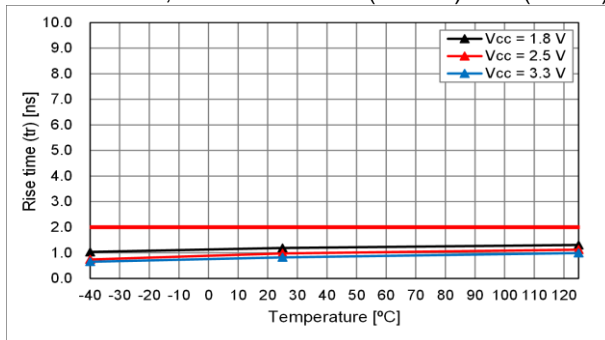

## (7-4) Symmetry

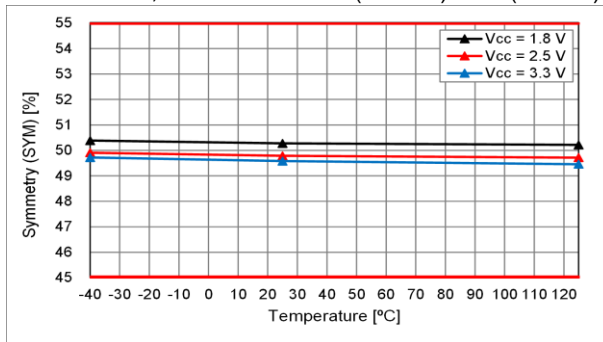
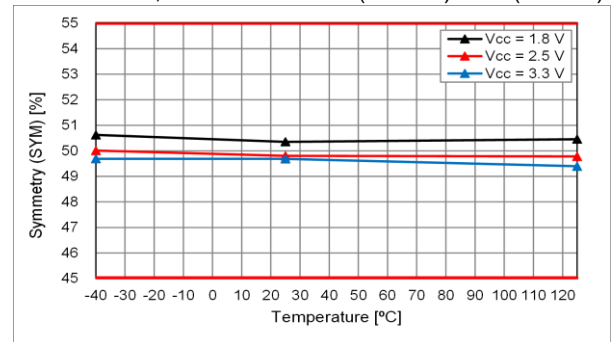
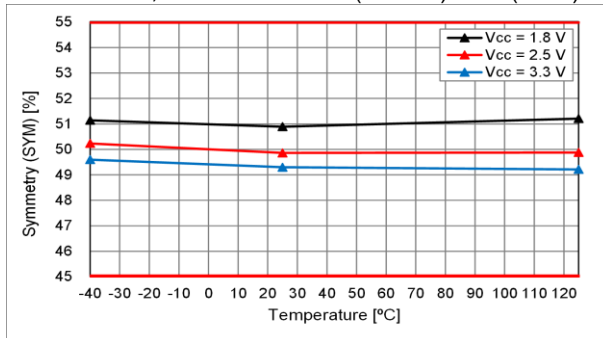
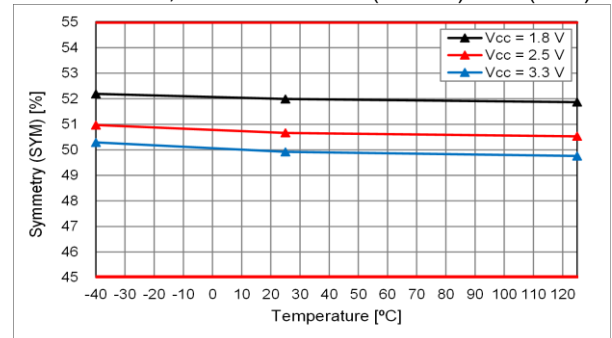
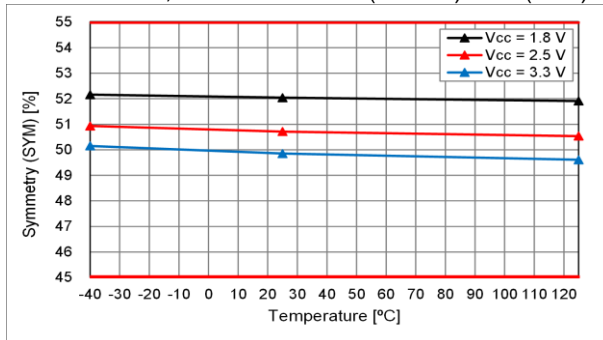
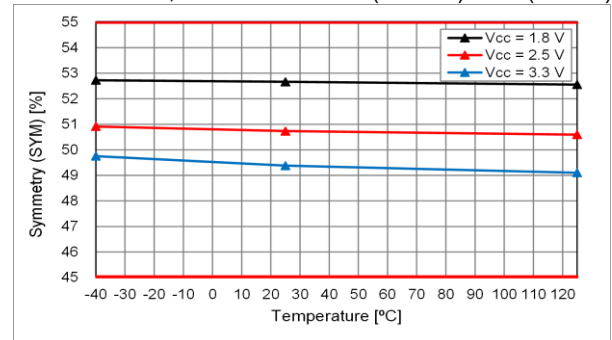
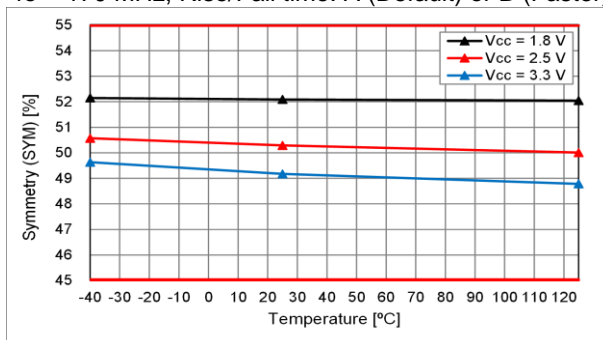
Temperature Characteristic ( $L_{CMOS} = 15 \text{ pF}$ ) $f_o = 25 \text{ MHz}$ , Rise/Fall time: A (Default) or E (Slower) $f_o = 50 \text{ MHz}$ , Rise/Fall time: A (Default) or E (Slower) $f_o = 75 \text{ MHz}$ , Rise/Fall time: A (Default) or D (Slow) $f_o = 100 \text{ MHz}$ , Rise/Fall time: A (Default) or C (Fast) $f_o = 125 \text{ MHz}$ , Rise/Fall time: A (Default) or C (Fast) $f_o = 150 \text{ MHz}$ , Rise/Fall time: A (Default) or B (Faster) $f_o = 170 \text{ MHz}$ , Rise/Fall time: A (Default) or B (Faster)

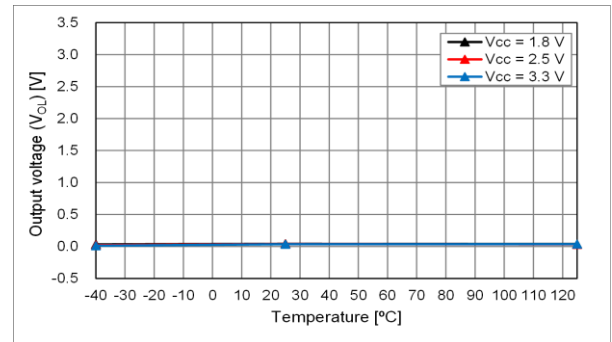
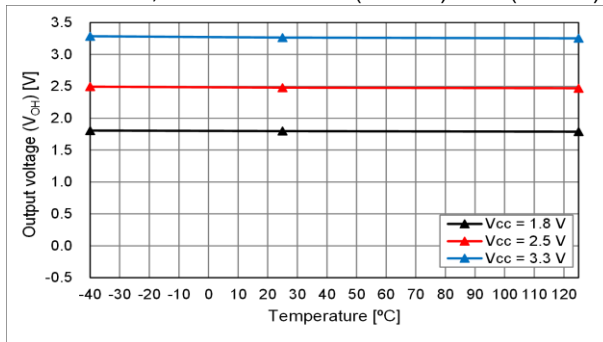
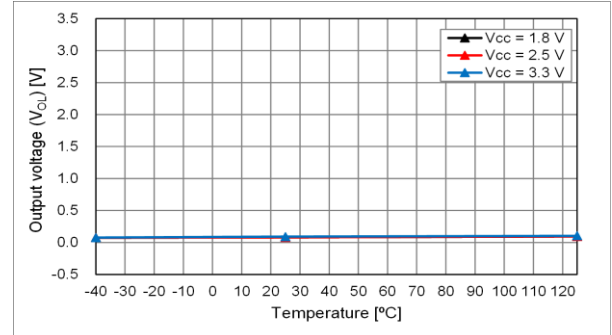
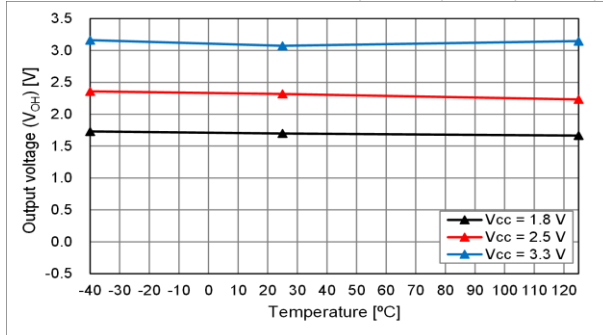
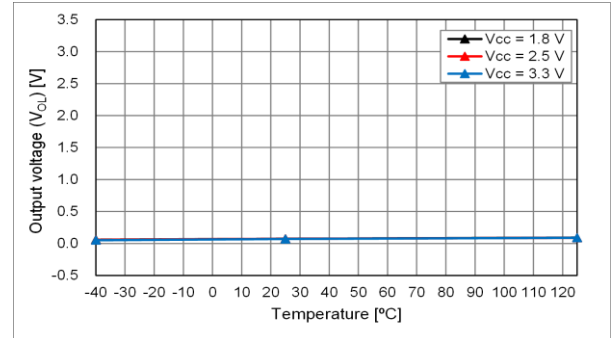
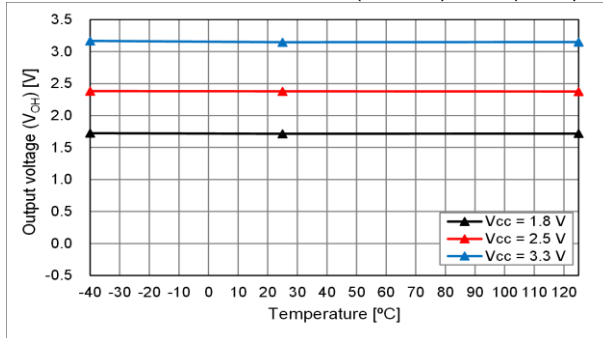
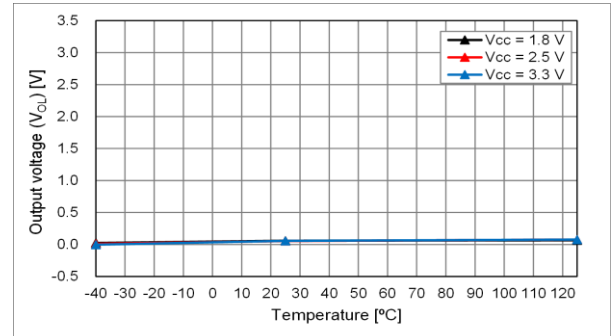
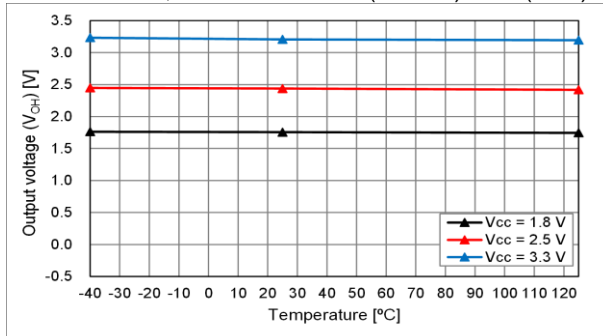

## (7-5) Output Voltage

Temperature Characteristic ( $L_{CMOS} = 15 \text{ pF}$ ) $f_o = 25 \text{ MHz}$ , Rise/Fall time: A (Default) or E (Slower) $f_o = 50 \text{ MHz}$ , Rise/Fall time: A (Default) or E (Slower) $f_o = 75 \text{ MHz}$ , Rise/Fall time: A (Default) or D (Slow) $f_o = 100 \text{ MHz}$ , Rise/Fall time: A (Default) or C (Fast)

## (7-5) Output Voltage [cont'd]

Temperature Characteristic (L\_CMOS = 15 pF)

fo = 125 MHz, Rise/Fall time: A (Default) or C (Fast)

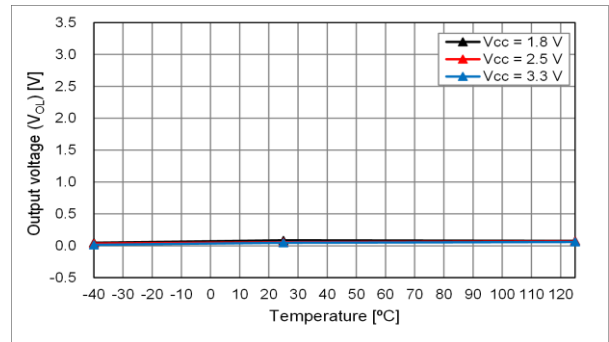
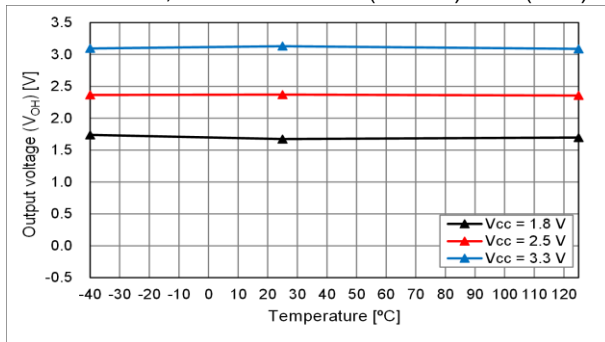

fo = 150 MHz, Rise/Fall time: A (Default) or B (Faster)

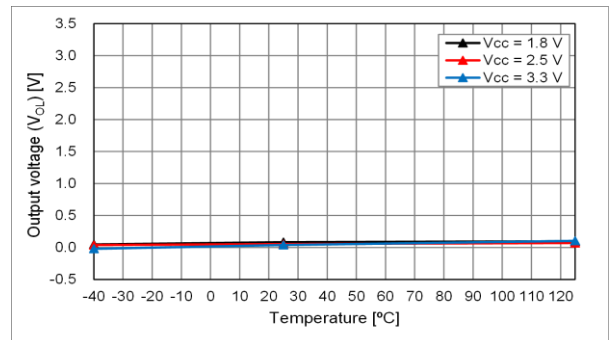
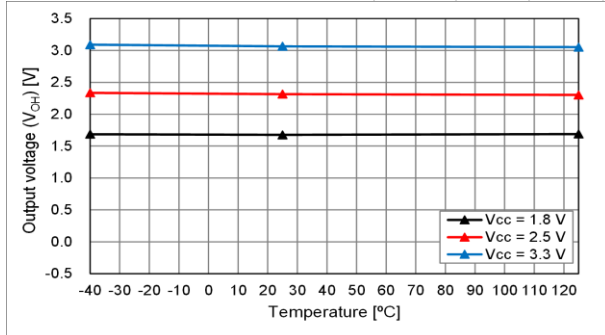

fo = 170 MHz, Rise/Fall time: A (Default) or B (Faster)

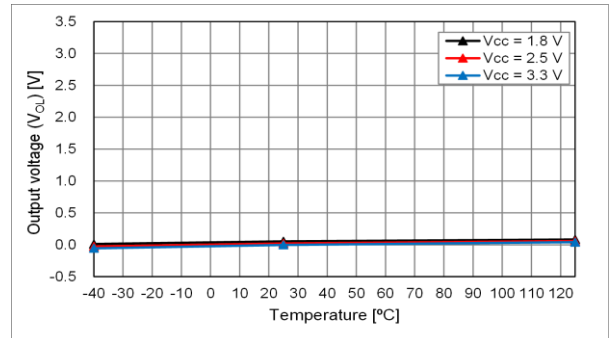
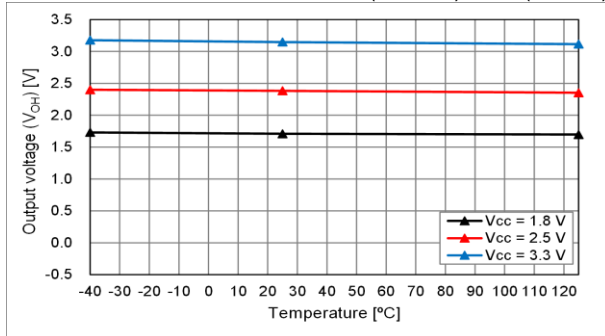

## (7-6) Output Waveform

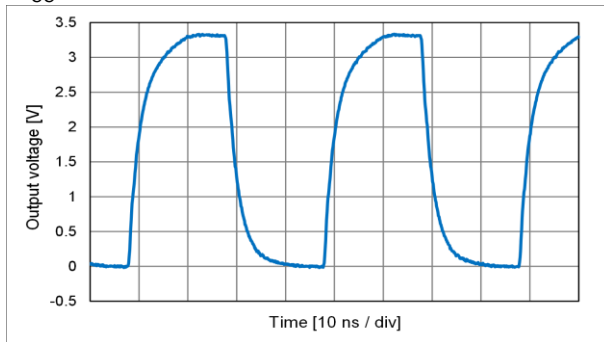
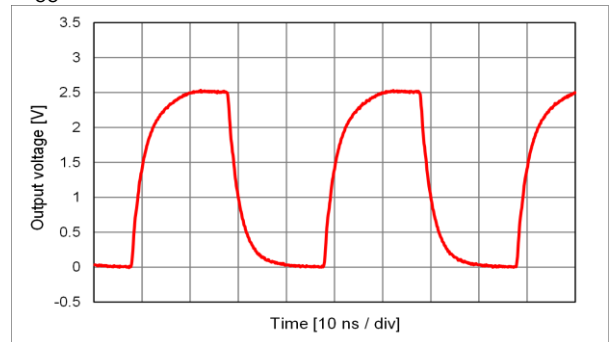
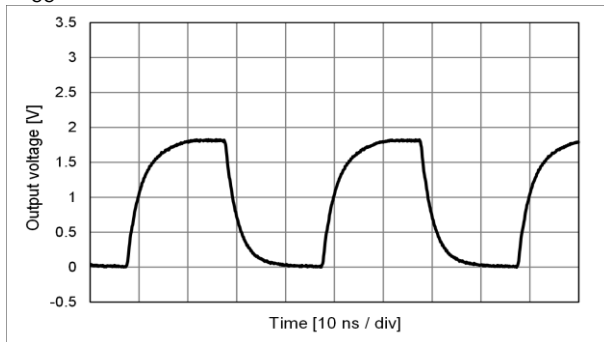
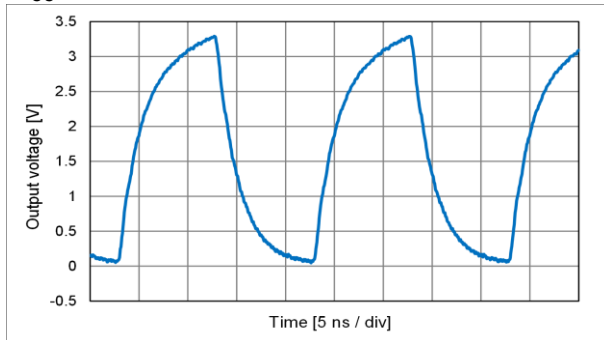
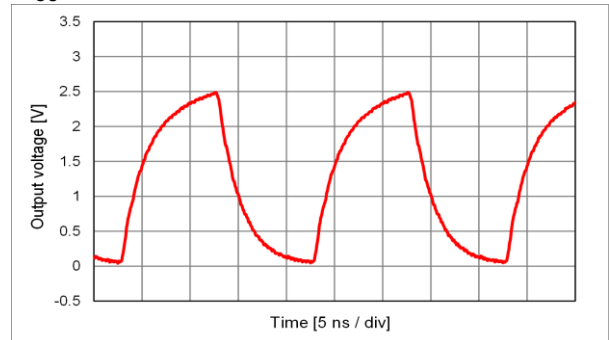
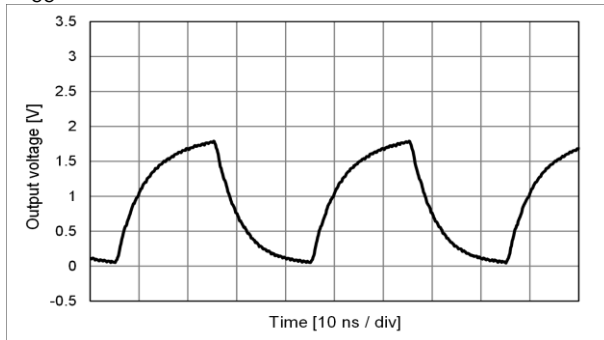
 $f_o = 25 \text{ MHz}$ ,  $L_{\text{CMOS}} = 15 \text{ pF}$ ,  $T_{\text{use}} = +25 \text{ }^\circ\text{C}$ , Rise/Fall time: A (Default) or E (Slower) $V_{\text{CC}} = 3.3 \text{ V}$  $V_{\text{CC}} = 2.5 \text{ V}$  $V_{\text{CC}} = 1.8 \text{ V}$  $f_o = 50 \text{ MHz}$ ,  $L_{\text{CMOS}} = 15 \text{ pF}$ ,  $T_{\text{use}} = +25 \text{ }^\circ\text{C}$ , Rise/Fall time: A (Default) or E (Slower) $V_{\text{CC}} = 3.3 \text{ V}$  $V_{\text{CC}} = 2.5 \text{ V}$  $V_{\text{CC}} = 1.8 \text{ V}$ 

## (7-6) Output Waveform [cont'd]

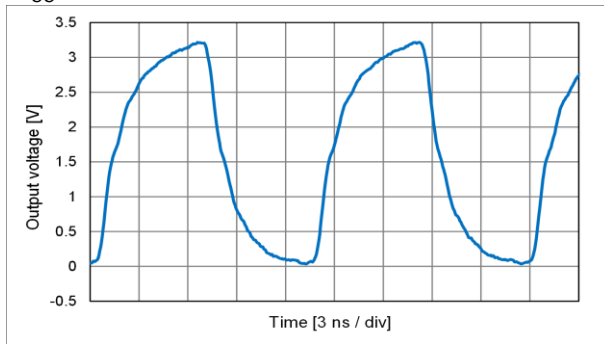
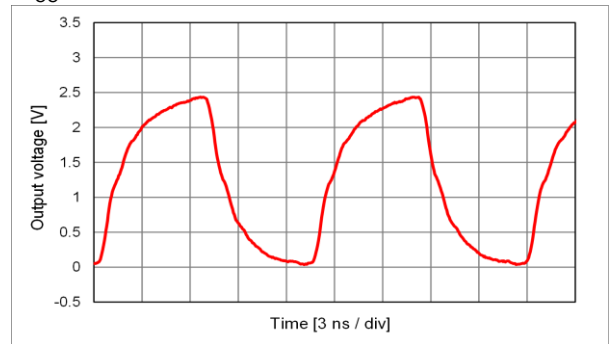
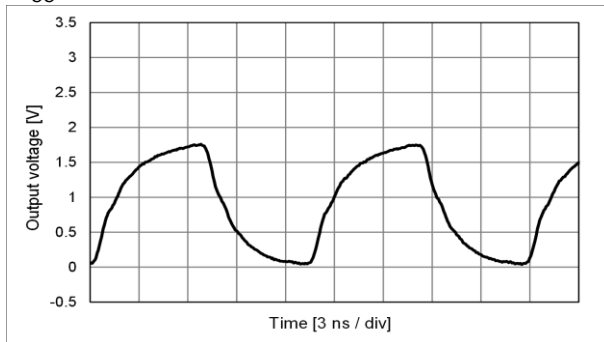
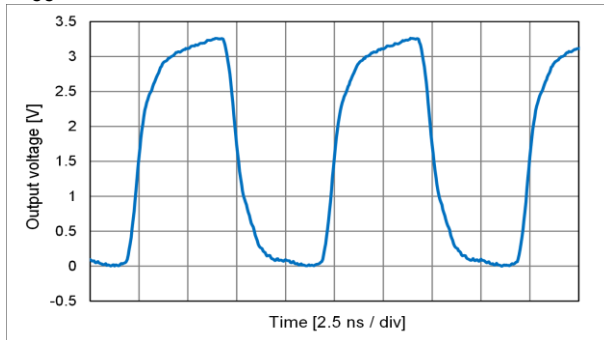
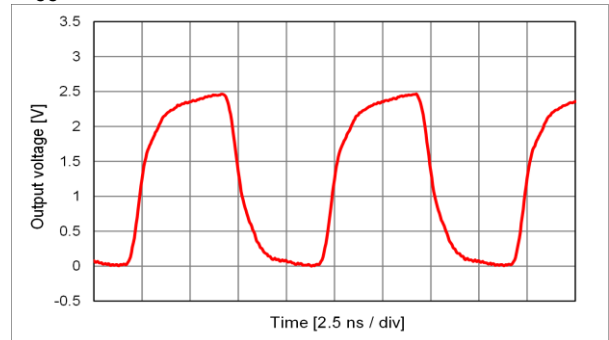
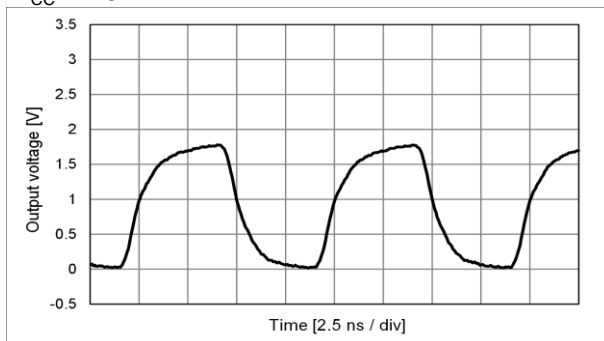
 $f_o = 75 \text{ MHz}$ ,  $L_{\text{CMOS}} = 15 \text{ pF}$ ,  $T_{\text{use}} = +25 \text{ }^\circ\text{C}$ , Rise/Fall time: A (Default) or D (Slow) $V_{\text{CC}} = 3.3 \text{ V}$  $V_{\text{CC}} = 2.5 \text{ V}$  $V_{\text{CC}} = 1.8 \text{ V}$  $f_o = 100 \text{ MHz}$ ,  $L_{\text{CMOS}} = 15 \text{ pF}$ ,  $T_{\text{use}} = +25 \text{ }^\circ\text{C}$ , Rise/Fall time: A (Default) or C (Fast) $V_{\text{CC}} = 3.3 \text{ V}$  $V_{\text{CC}} = 2.5 \text{ V}$  $V_{\text{CC}} = 1.8 \text{ V}$ 

## (7-6) Output Waveform [cont'd]

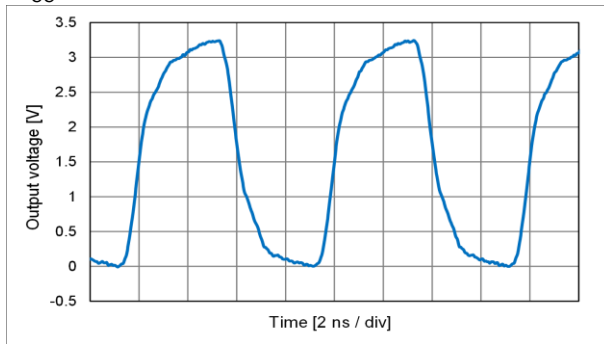
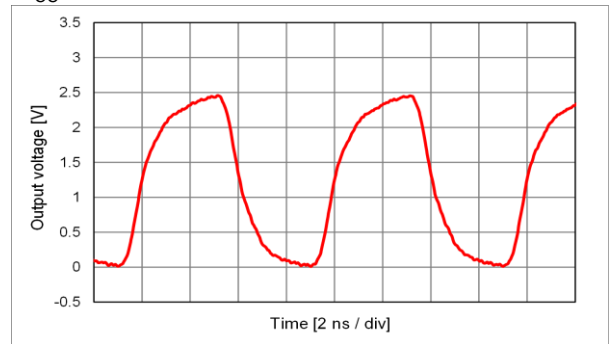
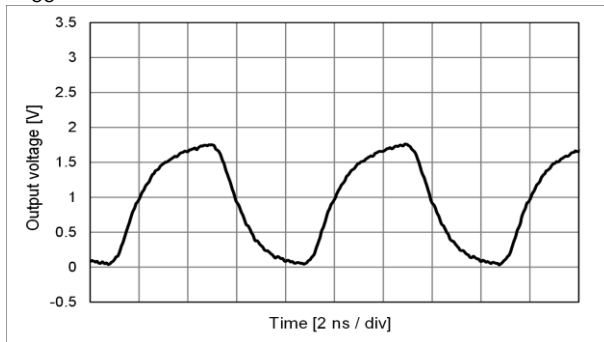
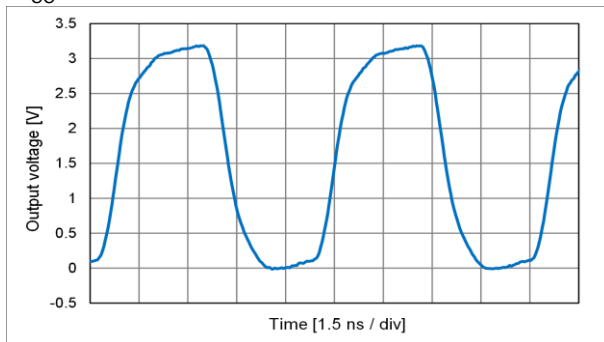
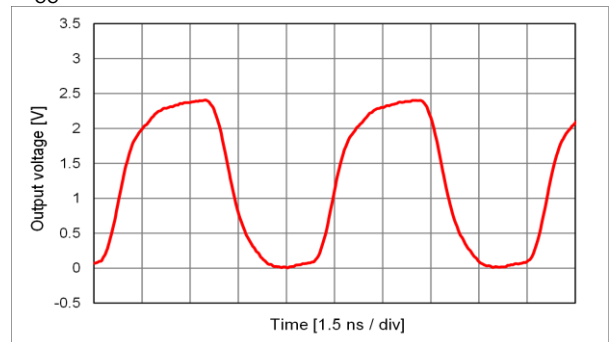
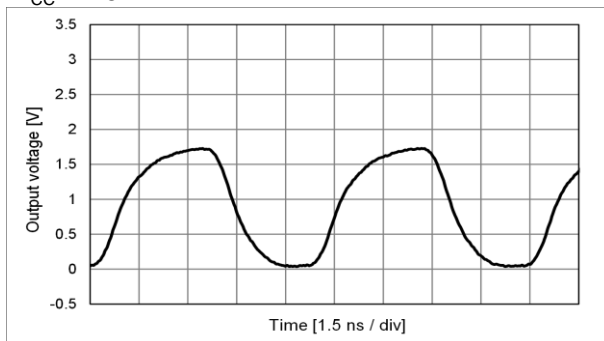
 $f_o = 125 \text{ MHz}$ ,  $L_{\text{CMOS}} = 15 \text{ pF}$ ,  $T_{\text{use}} = +25 \text{ }^\circ\text{C}$ , Rise/Fall time: A (Default) or C (Fast) $V_{\text{CC}} = 3.3 \text{ V}$  $V_{\text{CC}} = 2.5 \text{ V}$  $V_{\text{CC}} = 1.8 \text{ V}$  $f_o = 150 \text{ MHz}$ ,  $L_{\text{CMOS}} = 15 \text{ pF}$ ,  $T_{\text{use}} = +25 \text{ }^\circ\text{C}$ , Rise/Fall time: A (Default) or B (Faster) $V_{\text{CC}} = 3.3 \text{ V}$  $V_{\text{CC}} = 2.5 \text{ V}$  $V_{\text{CC}} = 1.8 \text{ V}$ 

## (7-6) Output Waveform [cont'd]

fo = 170 MHz, L\_CMOS = 15 pF, T\_use = +25 °C, Rise/Fall time: A (Default) or B (Faster)

V<sub>CC</sub> = 3.3 V

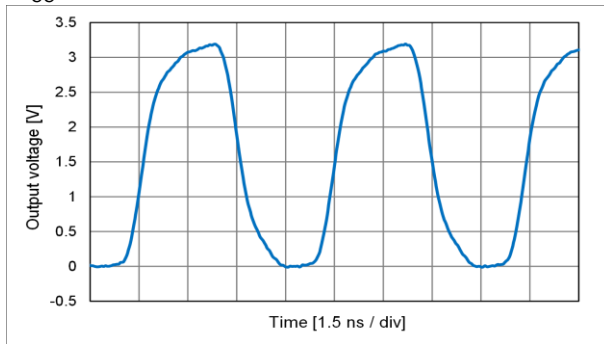

V<sub>CC</sub> = 2.5 V

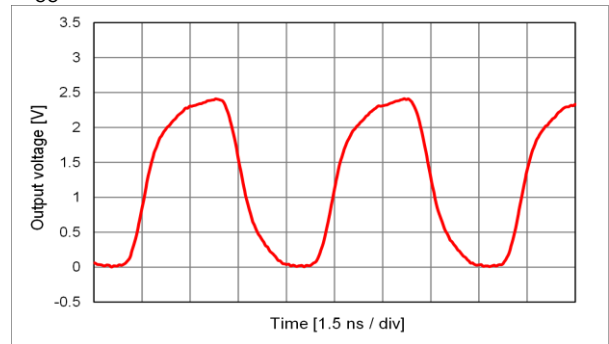

V<sub>CC</sub> = 1.8 V

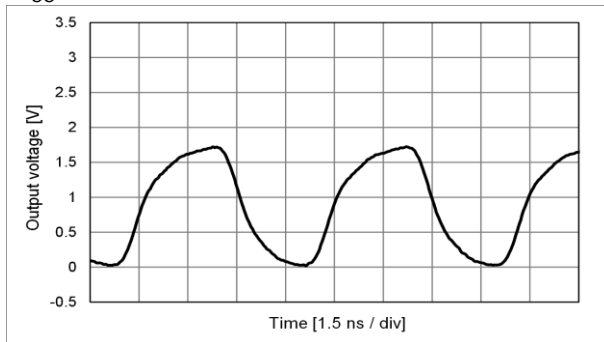

## (7-7) Phase Noise and Phase Jitter

fo = 25 MHz, T\_use = +25 °C

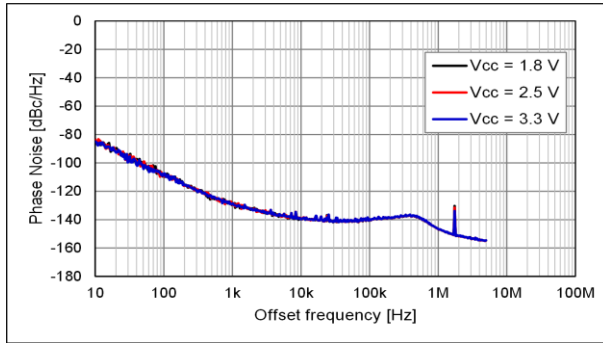

Phase jitter: 1.2 ps Typ.

Offset frequency: 12 kHz to 5 MHz

fo = 50 MHz, T\_use = +25 °C

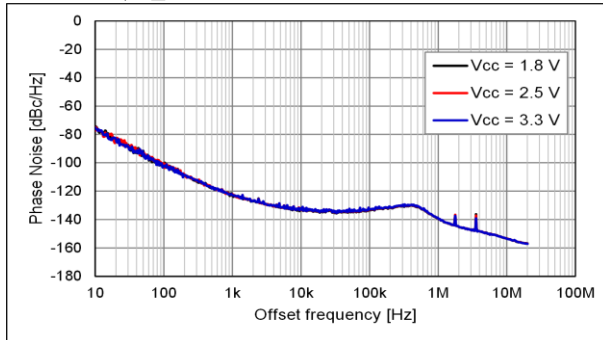

Phase jitter: 1.2 ps Typ.

Offset frequency: 12 kHz to 20 MHz

fo = 75 MHz, T\_use = +25 °C

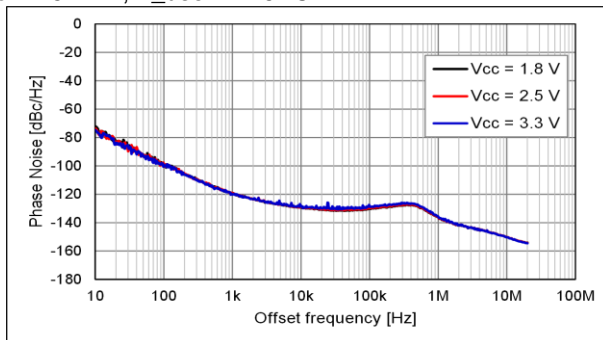

Phase jitter: 1.2 ps Typ.

Offset frequency: 12 kHz to 20 MHz

fo = 100 MHz, T\_use = +25 °C

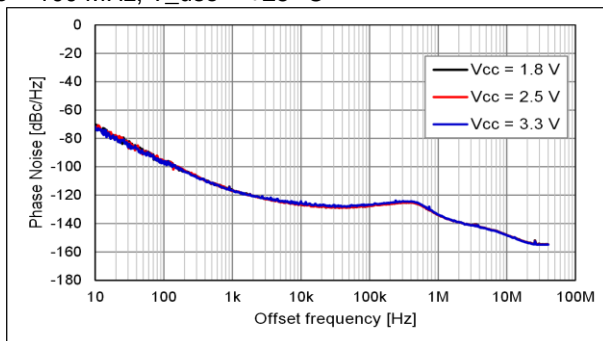

Phase jitter: 1.2 ps Typ.

Offset frequency: 12 kHz to 20 MHz

## (7-7) Phase Noise and Phase Jitter [cont'd]

fo = 125 MHz, T\_use = +25 °C

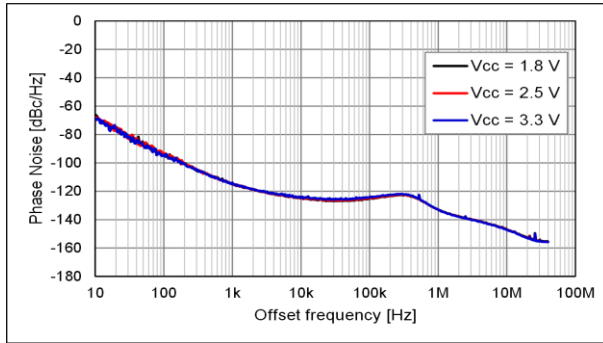

Phase jitter: 1.1 ps Typ.

Offset frequency: 12 kHz to 20 MHz

fo = 150 MHz, T\_use = +25 °C

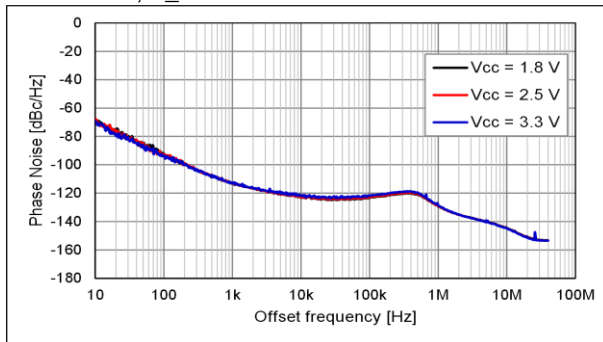

Phase jitter: 1.4 ps Typ.

Offset frequency: 12 kHz to 20 MHz

fo = 170 MHz, T\_use = +25 °C

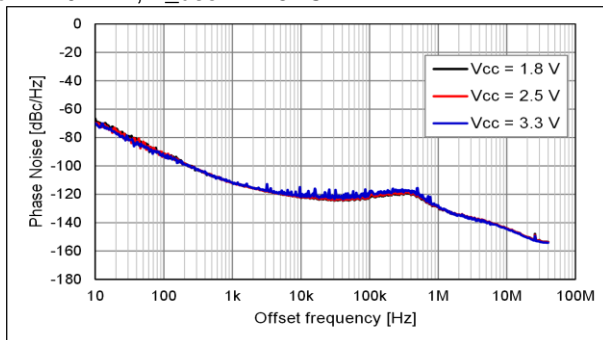

Phase jitter: 1.5 ps Typ.

Offset frequency: 12 kHz to 20 MHz



## [ 8 ] Test Circuit

## (8-1) Waveform Observation

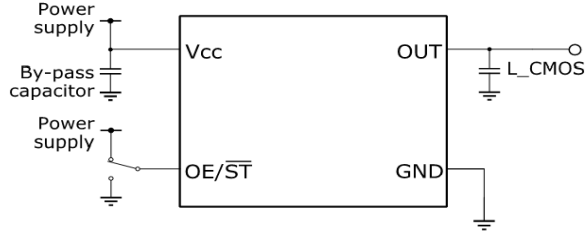
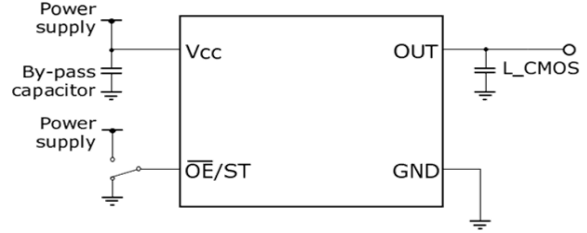
(1) #1 pin = OE/ $\overline{ST}$ (2) #1 pin =  $\overline{OE}$ /ST

## (8-2) Current Consumption Test

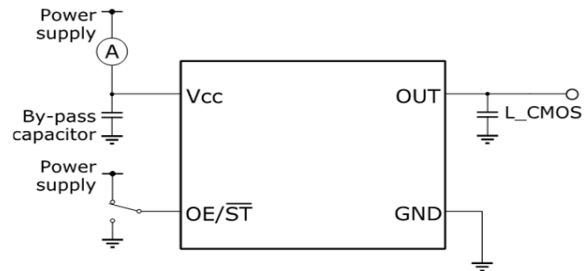
(1) #1 pin = OE/ $\overline{ST}$ 

\* Disable current test should be OE = GND.  
Stand-by current test should be  $\overline{ST}$  = GND.

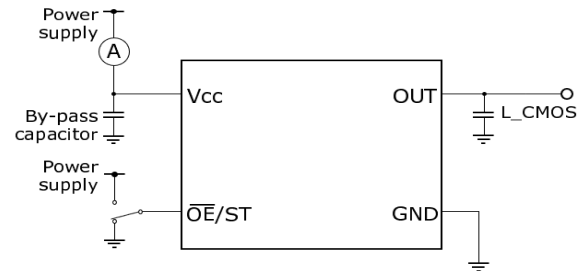
(2) #1 pin =  $\overline{OE}$ /ST

\* Disable current test should be  $\overline{OE}$  = V<sub>CC</sub>.  
Stand-by current test should be ST = V<sub>CC</sub>.

## (8-3) Jitter (Peak to Peak, RMS, Cycle to Cycle)

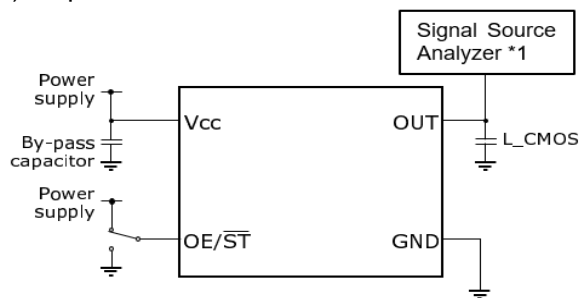
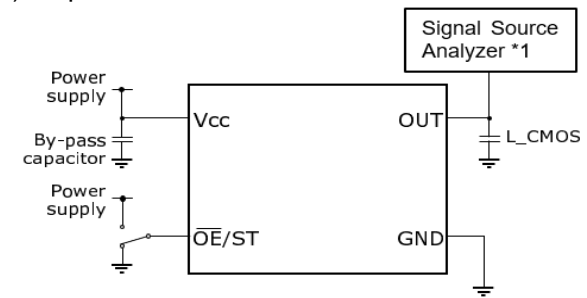
(1) #1 pin = OE/ $\overline{ST}$ (2) #1 pin =  $\overline{OE}$ /ST

\*1 Signal Source Analyzer: Keysight: E5052B, Minimum frequency = 10 MHz

## (8-4) Condition

## (1) Oscilloscope

The bandwidth should be minimum 5 times wider than measurement frequency

The probe ground should be placed closely to the test point and the lead length should be as short as possible

\* It is recommended to use miniature socket. (Don't use earth lead.)

## (2) L\_CMOS includes probe capacitance.

(3) A 0.01  $\mu$ F to 0.1  $\mu$ F bypass capacitor should be connected between V<sub>CC</sub> and GND pins located close to the device

## (4) Use a current meter with a low internal impedance

## (5) Power Supply

Power supply startup time (0 %V<sub>CC</sub> → 90 %V<sub>CC</sub>) should be between 5  $\mu$ s and 500 ms

Power supply impedance should be as low as possible and GND line should be as short as possible

## [ 9 ] Timing Chart

## (9-1) Output Waveform and Level

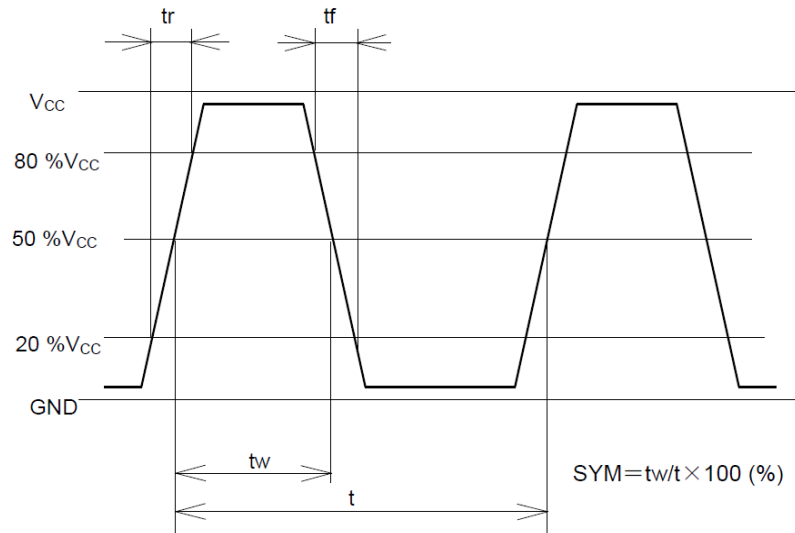
(9-2) OE/ $\overline{ST}$  Function and Timing

OE terminal	Osc. circuit	Output status
High or Open	Oscillation	Specified frequency: Enable
Low	Oscillation	Low (Weak pull down <sup>*3</sup> ): Disable

$\overline{ST}$ terminal	Osc. circuit	Output status
High	Oscillation	Specified frequency: Enable
Low	Oscillation stop	Low (Weak pull down <sup>*3</sup> ): Disable

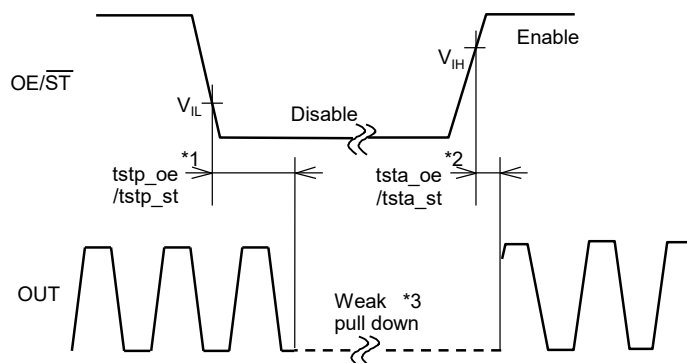

\*1 The period from OE/ $\overline{ST}$  = V<sub>IL</sub> to OUT = Disable (Low, weak pull down)

\*2 The period from OE/ $\overline{ST}$  = V<sub>IH</sub> to OUT = Enable

\*3 Pulled down with Output pull down resistance (R<sub>DN</sub>)

\* Judging the start of output when output waveform is observed.

\* OE/ $\overline{ST}$  terminal voltage level should not exceed supply voltage when using OE/ $\overline{ST}$  function. Please note that OE/ $\overline{ST}$  rise time should not exceed supply voltage rise time at the start-up.

\* Please do not use the  $\overline{ST}$  terminal with the open state.

If output should be enabled with the open state, please use Output Enable function.

(9-3)  $\overline{\text{OE}}/\text{ST}$  Function and Timing

$\overline{\text{OE}}$ terminal	Osc. circuit	Output status
Low or Open	Oscillation	Specified frequency: Enable
High	Oscillation	Low (Weak pull down <sup>*3</sup> ): Disable

ST terminal	Osc. circuit	Output status
Low	Oscillation	Specified frequency: Enable
High	Oscillation stop	Low (Weak pull down <sup>*3</sup> ): Disable

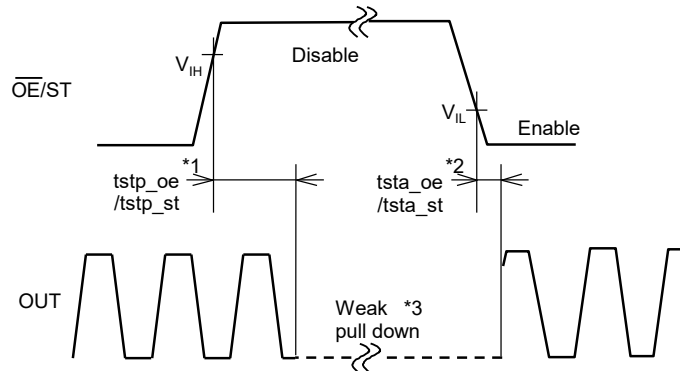

\*1 The period from  $\overline{\text{OE}}/\text{ST} = V_{\text{IH}}$  to  $\text{OUT} = \text{Disable}$  (Low, weak pull down)

\*2 The period from  $\overline{\text{OE}}/\text{ST} = V_{\text{IL}}$  to  $\text{OUT} = \text{Enable}$

\*3 Pulled down with Output pull down resistance ( $R_{\text{DN}}$ )

\* Judging the start of output when output waveform is observed.

\*  $\overline{\text{OE}}/\text{ST}$  terminal voltage level should not exceed supply voltage when using  $\overline{\text{OE}}/\text{ST}$  function.

\* Please do not use the ST terminal with the open state.

If output should be enabled with the open state, please use Output Enable function.

[ 10 ] Outline Drawing and Recommended Footprint

Units: mm

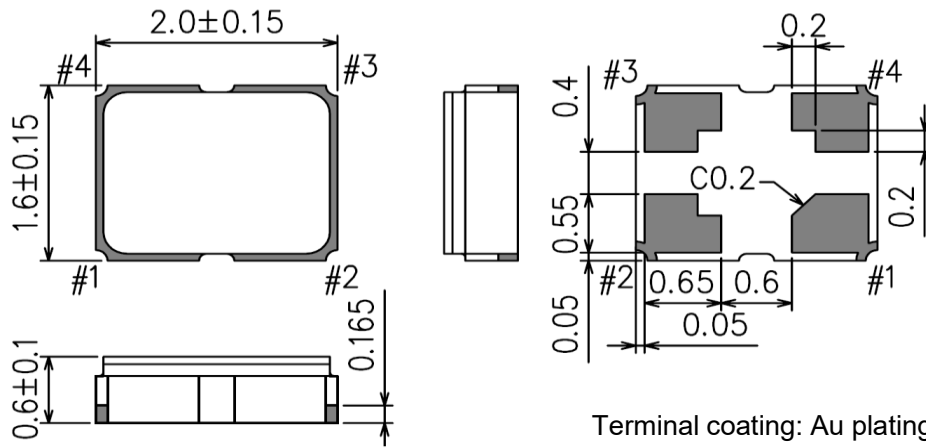

Terminal coating: Au plating

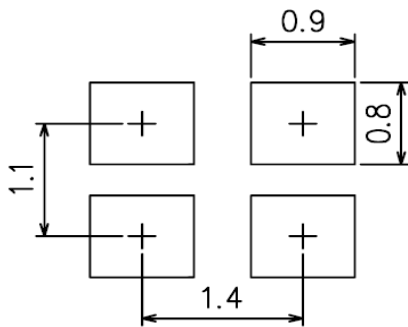

For stable operation, it is recommended that 0.01  $\mu$ F to 0.1  $\mu$ F bypass capacitor should be connected between  $V_{CC}$  and GND and placed as close to the  $V_{CC}$  pin as possible.

Reference Weight Typ.: 7.3 mg

Terminal Assignment

Pin #	Name	Function
#1	OE	Output Enable High <sup>*1</sup> or Open: Specified frequency output from OUT pin Low: OUT pin is low (pull down with 500 k $\Omega$ ), only output driver is disabled
	$\bar{O}E$	Output Enable Low <sup>*2</sup> or Open: Specified frequency output from OUT pin High: OUT pin is low (pull down with 500 k $\Omega$ ), only output driver is disabled
	$\bar{S}T$	Standby High <sup>*1 *3</sup> : Specified frequency output from OUT pin Low: OUT pin is low (pull down with 500 k $\Omega$ ) Device goes to standby mode. Supply current reduces to the least as $I_{std}$
	ST	Standby Low <sup>*2 *3</sup> : Specified frequency output from OUT pin High: OUT pin is low (pull down with 500 k $\Omega$ ) Device goes to standby mode. Supply current reduces to the least as $I_{std}$
#2	GND	Ground
#3	OUT	Clock output
#4	$V_{CC}$	Power supply

\*1 If fixing it at High, please connect to  $V_{CC}$  directly.  
 \*2 If fixing it at Low, please connect to GND directly.  
 \*3 If necessary to use Open, please select Output Enable function.

Marking

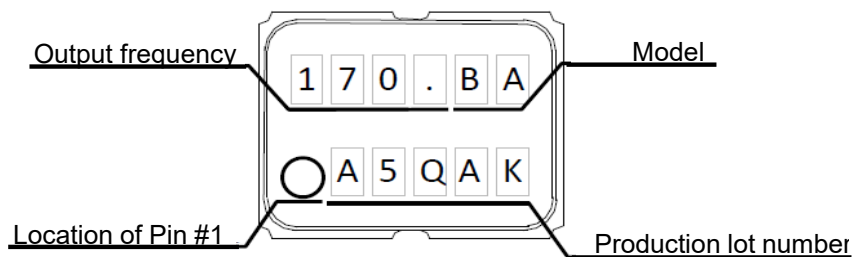

## [ 11 ] Moisture Sensitivity Level

Parameter	Specification	Conditions
MSL	LEVEL 1	IPC/JEDEC J-STD-020D.1

## [ 12 ] Reflow Profiles

IPC/JEDEC J-STD-020D.1

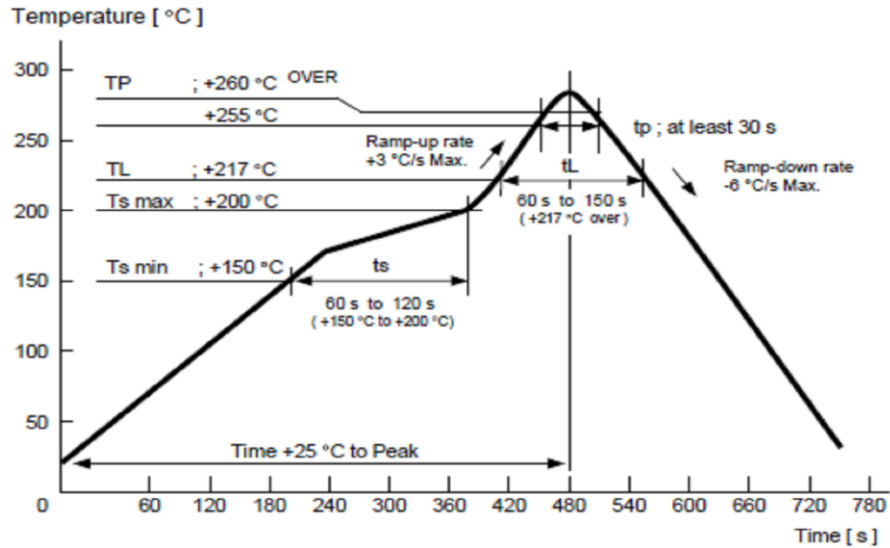

## [ 13 ] Packing Information

## (13-1) Packing Quantity

The last two digits of the Product Number (X1G005991xxxxxx) are a code that defines the packing quantity. The standard is "16" for a 3 000 pcs/Reel.

## (13-2) Taping Specification

Subject to EIA-481, IEC-60286 and JIS C0806

## (1) Tape Dimensions

Carrier Tape Material: PS (Polystyrene)

Top Tape Material: PET (Polyethylene Terephthalate) + PE (Polyethylene)

Units: mm

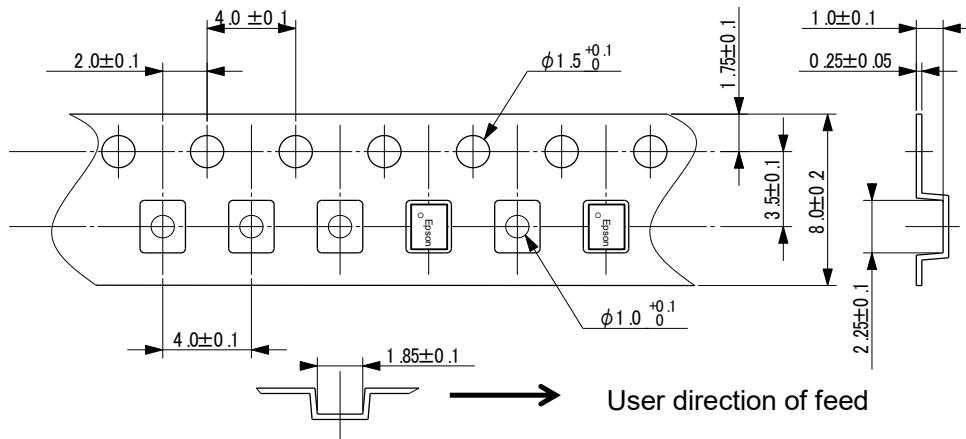

## (2) Reel Dimensions

Reel Material: PS (Polystyrene)

Units: mm

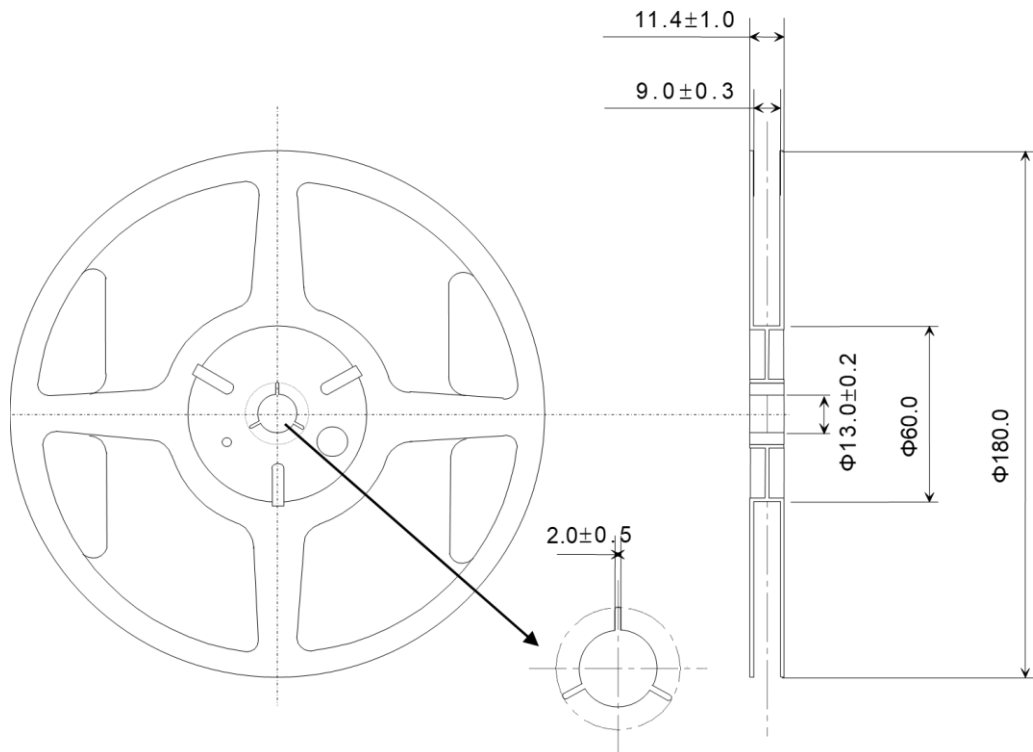

## (3) Storage Environment

We recommend to keep less than +30 °C and 85 %RH of humidity in a packed condition, and to use it less than 6 months after delivery.

## [ 14 ] Handling Precautions

Prior to using this product, please carefully read the section entitled "Precautions" on our Web site (<https://www5.epsondevice.com/en/information/#precaution>) for instructions on how to handle and use the product properly to ensure optimal performance of the product in your equipment.

Before using the product under any conditions other than those specified therein, please consult with us to verify and confirm that the performance of the product will not be negatively affected by use under such conditions.

In addition to the foregoing precautions, in order to avoid the deteriorating performance of the product, we strongly recommend that you DO NOT use the product under ANY of the following conditions:

- (1) Do not expose this product to excessive mechanical shock or vibration.
- (2) This product can be damaged by mechanical shock during the soldering process depending on the equipment used, process conditions, and any impact forces experienced. Always follow appropriate procedures, particularly when changing the assembly process in any way and be sure to follow applicable process qualification standards before starting production.
- (3) These devices are sensitive to ESD, use appropriate precautions during handling, assembly, test, shipment, and installation.
- (4) The use of ultrasonic technology for cleaning, bonding, etc. can damage the Xtal unit inside this product. Please carefully check for this consideration before using ultrasonic equipment for volume production with this product.
- (5) Noise and ripple on the power supply may have undesirable effects on operation and cause degradation of phase noise characteristics. Evaluate the operation of this device with appropriate power supplies carefully before use.
- (6) When applying power, ensure that the supply voltage increases monotonically for proper operation. On power down, do not reapply power until the supplies, bypass capacitors, and any bulk capacitors are completely discharged since that may cause the unit to malfunction.
- (7) Aging specifications are estimated from environmental reliability tests and expected frequency variation over time. They do not provide a guarantee of aging over the product lifecycle.
- (8) The metal cap on top of the device is directly connected to the GND terminal. Take necessary precautions to prevent any conductor not at ground potential from contacting the cap as that could cause a short circuit to GND.
- (9) Do not route any signal lines, supply voltage lines, or GND lines underneath the area where the oscillators are mounted including any internal layers and on the opposite side of the PCB. To avoid any issues due to interference of other signal lines, please take care not to place signal lines near the product as this may have an adverse affect on the performance of the product.
- (10) A bypass capacitor of the recommended value(s) must be connected between the  $V_{CC}$  and GND terminals of the product. Whenever possible, mount the capacitor(s) on the same side of the PCB and as close to the product as possible to keep the routing traces short.
- (11) Power supply connections to  $V_{CC}$  and GND pins should be routed as thick as possible while keeping the high frequency impedance low in order to get the best performance.
- (12) The use of a filter or similar element in series with the power supply connections to protect from electromagnetic radiation noise may increase the high frequency impedance of the power supply line and may cause the oscillator to not operate properly. Please verify the design to ensure sufficient operational margin prior to use.
- (13) Keep PCB routing from the output terminal(s) to the load as short as possible for best performance.
- (14) The Enable (OE/ $\overline{OE}$ / $\overline{ST}$ /ST) input terminal is high impedance and so susceptible to noise. Connect it to a low impedance source when used and when not used it is recommended to connect it to  $V_{CC}$  for OE/ $\overline{ST}$  inputs and GND for  $\overline{OE}$ /ST inputs.
- (15) Do not short the output to GND as that will damage the product. Always use with an appropriate load resistor connected.
- (16) This product should be reflowed no more than 3 times.
 

[Availability of mounting conditions]	
Reflow on the board	Available
Reflow under the board	The parts may fall. Please judge whether it is possible to implement.
Soldering pot/bath (Dip soldering system, Flow soldering system)	<b>Not Available</b>
Soldering iron	Available

If rework is needed after reflow, please correct it with a soldering iron with the tip set for a temperature of +350 °C or less and only contact each terminal once and for no more than 5 seconds. If this product is mounted on the bottom of the board during a reflow please check that it soldered down properly afterwards.
- (17) Product failures during the warranty period only apply when the product is used according to the recommended operating conditions described in the specifications. Products that have been opened for analysis or damaged will not be covered. It is recommended to store and use in normal temperature and humidity environments described in the specifications to ensure frequency accuracy and prevent moisture condensation. If the product is stored for more than one year, please confirm the pin solderability prior to use.
- (18) If the oscillation circuit is exposed to condensation, the frequency may change or oscillation may stop. Do not use in any conditions where condensation occurs.
- (19) Do not store or use the product in an environment where it can be exposed to chemical substances that are corrosive to metal or plastics such as salt water, organic solvents, chemical gasses, etc. Do not use the product when it is exposed to sunlight, dust, corrosive gasses, or other materials for long periods of time.
- (20) When using water-soluble solder flux make sure to completely remove the flux residue after soldering. Pay particular attention when the residues contain active halogens which will negatively affect the product and its performance.
- (21) Terminals on the side of the product are internally connected to the IC, be careful not to cause short-circuits or reduce the insulation resistance of them in any way.
- (22) Should any customer use the product in any manner contrary to the precautions and/or advice herein, such use shall be done at the customer's own risk.

## PROMOTION OF ENVIRONMENTAL MANAGEMENT SYSTEM CONFORMING TO INTERNATIONAL STANDARDS

At Seiko Epson, all environmental initiatives operate under the Plan-Do-Check-Action (PDCA) cycle designed to achieve continuous improvements. The environmental management system (EMS) operates under the ISO 14001 environmental management standard.

All of our major manufacturing and non-manufacturing sites, in Japan and overseas, completed the acquisition of ISO 14001 certification.



ISO 14000 is an international standard for environmental management that was established by the International Standards Organization in 1996 against the background of growing concern regarding global warming, destruction of the ozone layer, and global deforestation.

## WORKING FOR HIGH QUALITY

In order provide high quality and reliable products and services than meet customer needs, Seiko Epson made early efforts towards obtaining ISO9000 series certification and has acquired ISO9001 for all business establishments in Japan and abroad. We have also acquired IATF 16949 certification that is requested strongly by major manufacturers as standard.

IATF 16949 is the international standard that added the sector-specific supplemental requirements for automotive industry based on ISO9001.

### ■ Explanation of marks used in this datasheet

	<p>●Pb free.</p>
	<p>●Complies with EU RoHS directive. *About the products without the Pb-free mark. Contains Pb in products exempted by EU RoHS directive (Contains Pb in sealing glass, high melting temperature type solder or other)</p>
	<p>●Designed for automotive applications such as Car Multimedia, Body Electronics, Remote Keyless Entry etc.</p>

NOTICE: PLEASE READ CAREFULLY BELOW BEFORE THE USE OF THIS DOCUMENT ©Seiko Epson Corporation

- The content of this document is subject to change without notice. Before purchasing or using Epson products, please contact with sales representative of Seiko Epson Corporation ("Epson") for the latest information and be always sure to check the latest information published on Epson's official web sites and resources.
- This document may not be copied, reproduced, or used for any other purposes, in whole or in part, without Epson's prior consent.
- Information provided in this document including, but not limited to application circuits, programs and usage, is for reference purpose only. Epson makes no guarantees against any infringements or damages to any third parties' intellectual property rights or any other rights resulting from the information. This document does not grant you any licenses, any intellectual property rights or any other rights with respect to Epson products owned by Epson or any third parties.
- Using Epson products, you shall be responsible for safe design in your products; that is, your hardware, software, and/or systems shall be designed enough to prevent any critical harm or damages to life, health or property, even if any malfunction or failure might be caused by Epson products. In designing your products with Epson products, please be sure to check and comply with the latest information regarding Epson products (including, but not limited to this document, specifications, data sheets, manuals, and Epson's web site). Using technical contents such as product data, graphic and chart, and technical information, including programs, algorithms and application circuit examples under this document, you shall evaluate your products thoroughly both in stand-alone basis and within your overall systems. You shall be solely responsible for deciding whether to adopt/use Epson products with your products.
- Epson has prepared this document carefully to be accurate and dependable, but Epson does not guarantee that the information is always accurate and complete. Epson assumes no responsibility for any damages you incurred due to any misinformation in this document.
- No dismantling, analysis, reverse engineering, modification, alteration, adaptation, reproduction, etc., of Epson products is allowed.
- Epson products have been designed, developed and manufactured to be used in general electronic applications and specifically requires particular quality or extremely high reliability in order to refrain from causing any malfunction or failure leading to critical harm to life and health, serious property damage, or severe impact on society, including, but not limited to listed below ("Specific Purpose"). Therefore, you are strongly advised to use Epson products only for the Anticipated Purpose. Should you desire to purchase and use Epson products for Specific Purpose, Epson makes no warranty and disclaims with respect to Epson products, whether express or implied, including without limitation any implied warranty of merchantability or fitness for any Specific Purpose. Please be sure to contact our sales representative in advance, if you desire Epson products for Specific Purpose:  
Space equipment (artificial satellites, rockets, etc.)/ Transportation vehicles and their control equipment (automobiles, aircraft, trains, ships, etc.) / Medical equipment/ Relay equipment to be placed on sea floor/ Power station control equipment / Disaster or crime prevention equipment/Traffic control equipment/ Financial equipment  
Other applications requiring similar levels of reliability as the above
- Epson products listed in this document and our associated technologies shall not be used in any equipment or systems that laws and regulations in Japan or any other countries prohibit to manufacture, use or sell. Furthermore, Epson products and our associated technologies shall not be used for the purposes of military weapons development (e.g. mass destruction weapons), military use, or any other military applications. If exporting Epson products or our associated technologies, please be sure to comply with the Foreign Exchange and Foreign Trade Control Act in Japan, Export Administration Regulations in the U.S.A (EAR) and other export-related laws and regulations in Japan and any other countries and to follow their required procedures.
- Epson assumes no responsibility for any damages (whether direct or indirect) caused by or in relation with your non-compliance with the terms and conditions in this document or for any damages (whether direct or indirect) incurred by any third party that you give, transfer or assign Epson products.
- For more details or other concerns about this document, please contact our sales representative.
- Company names and product names listed in this document are trademarks or registered trademarks of their respective companies.